

Ruled lines for notes.

EGV

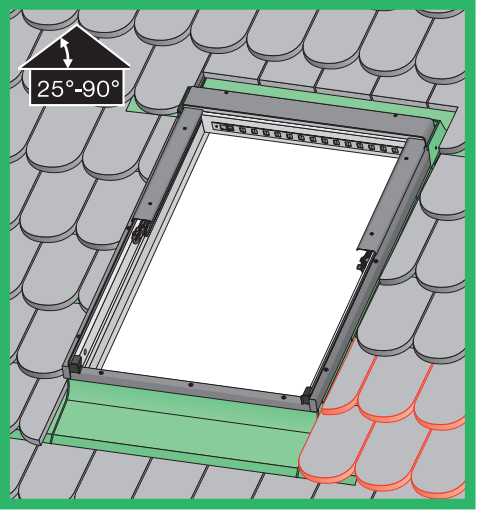

25°-90°

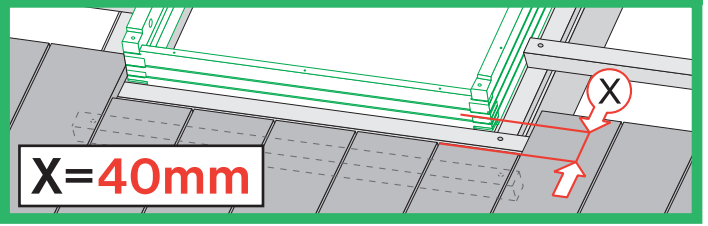
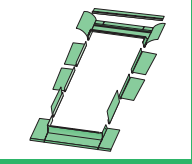
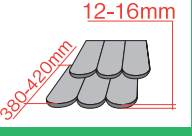

X=40mm

EGV

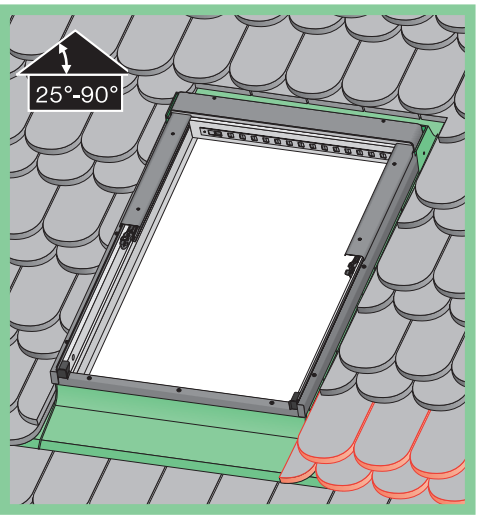

25°-90°

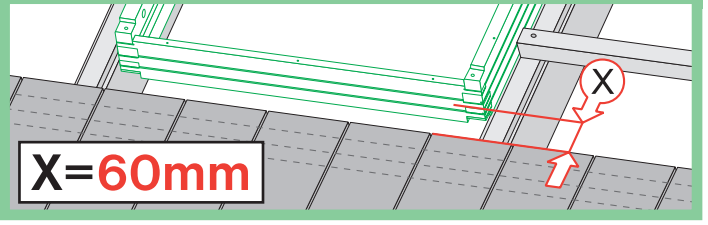
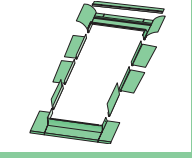
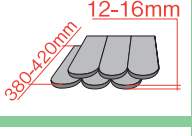

X=60mm

NC 243

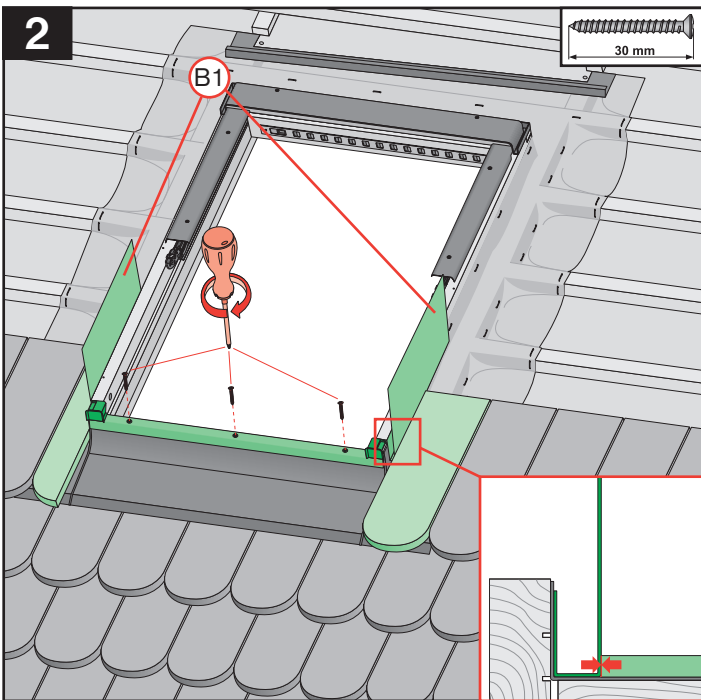
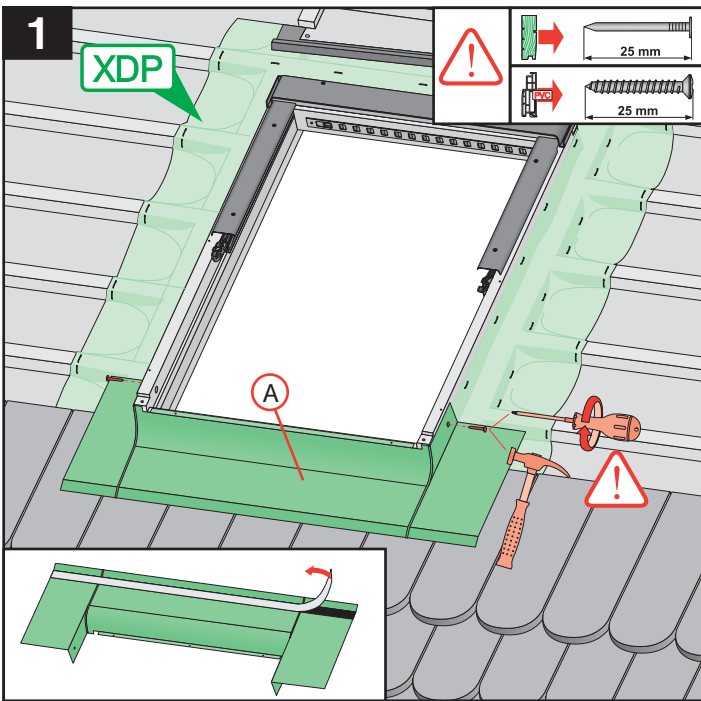
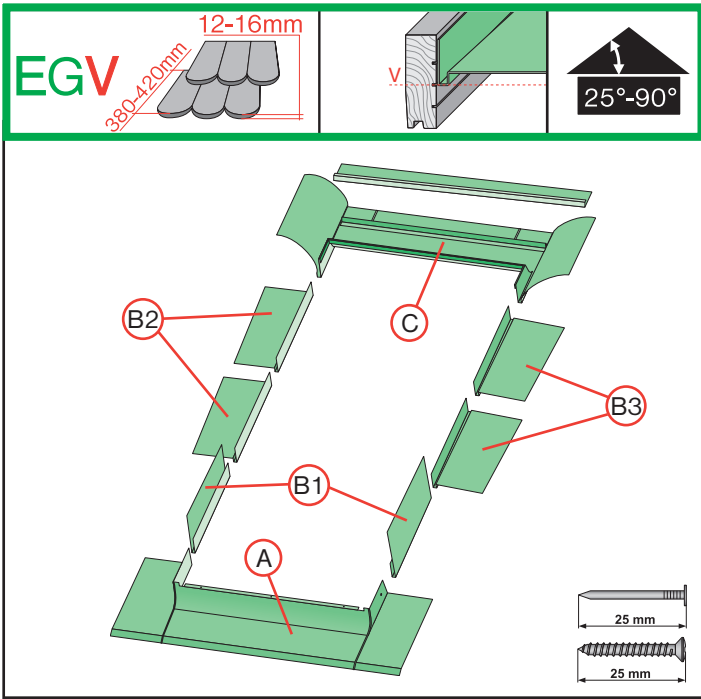

2

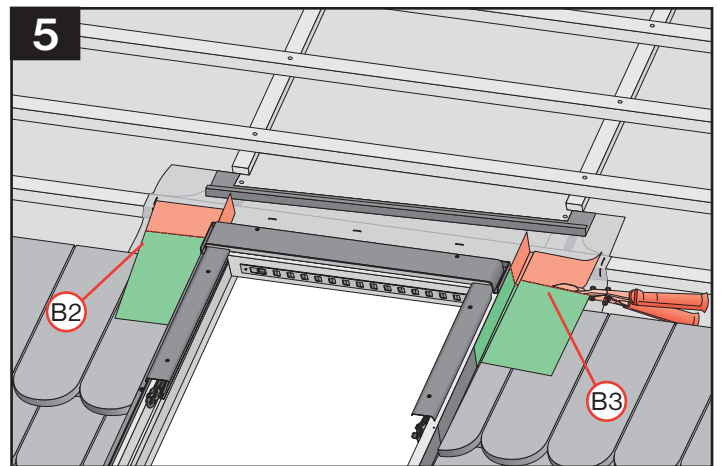
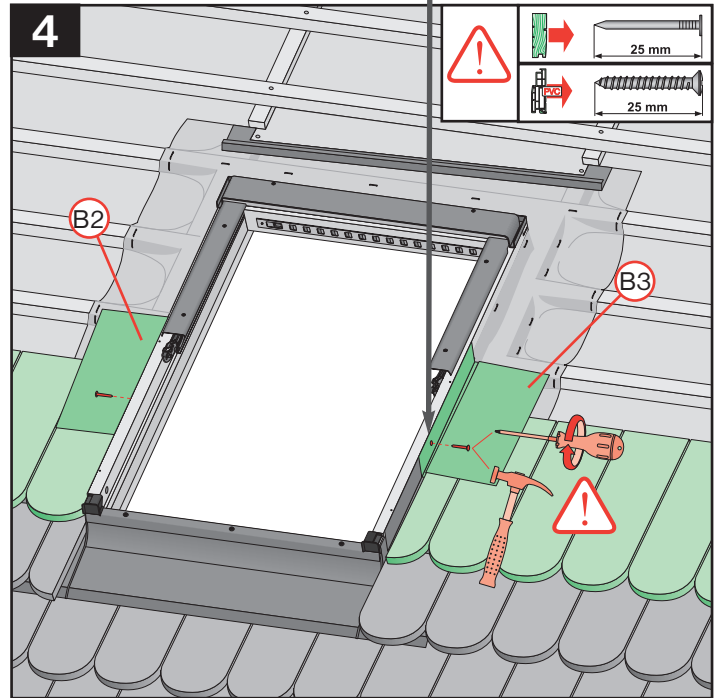
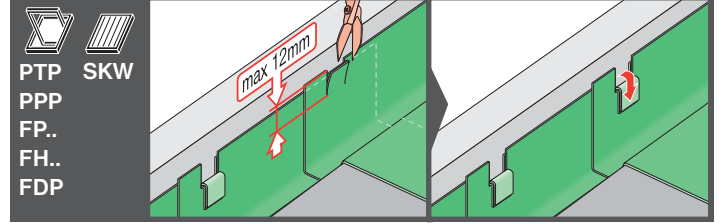
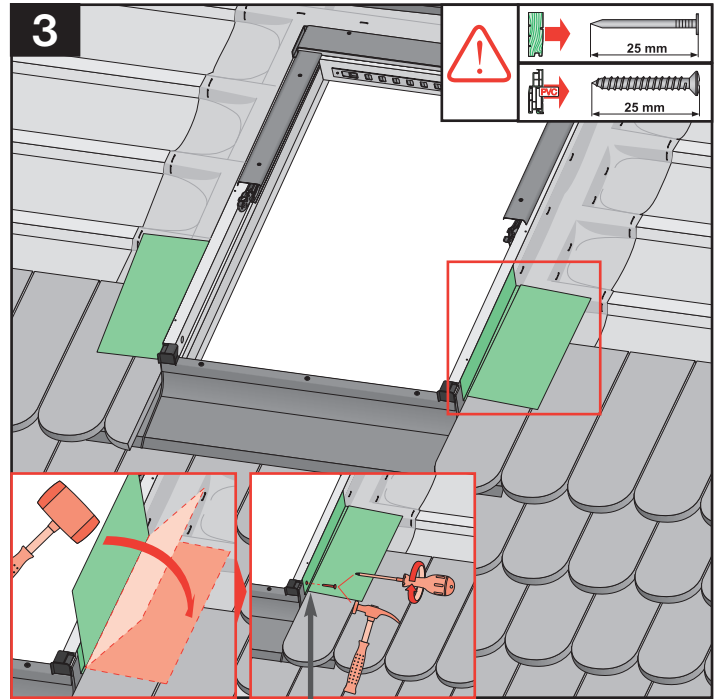

3

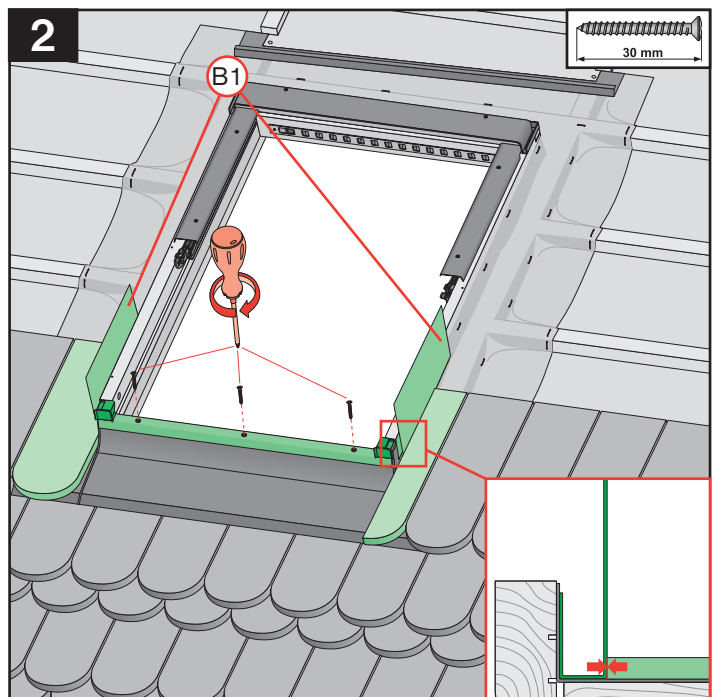
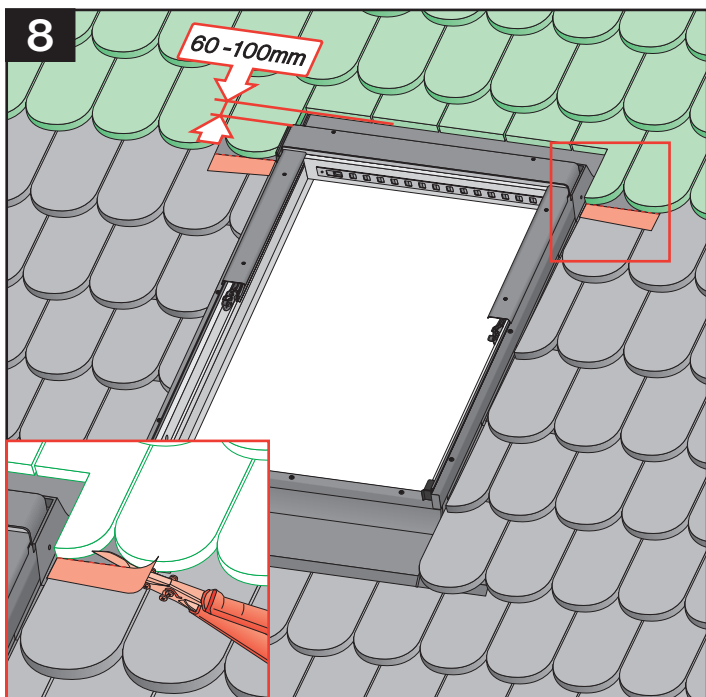
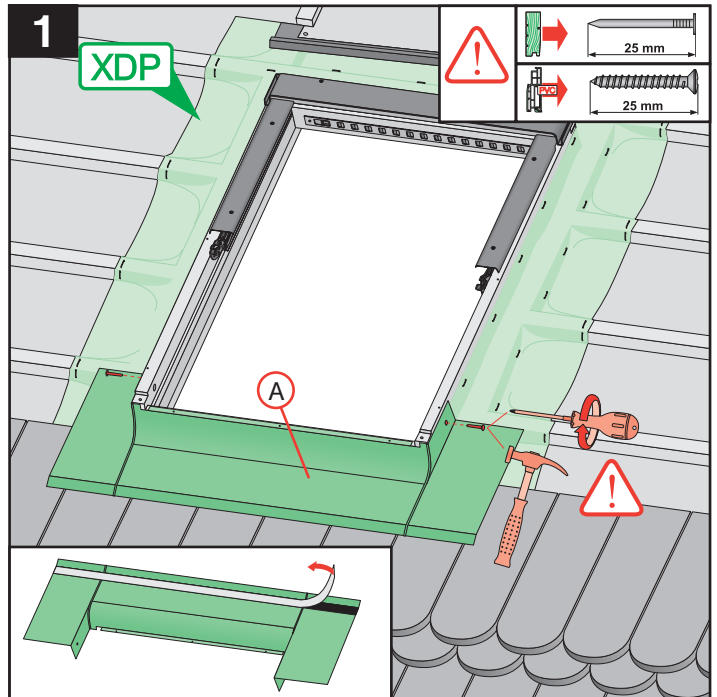
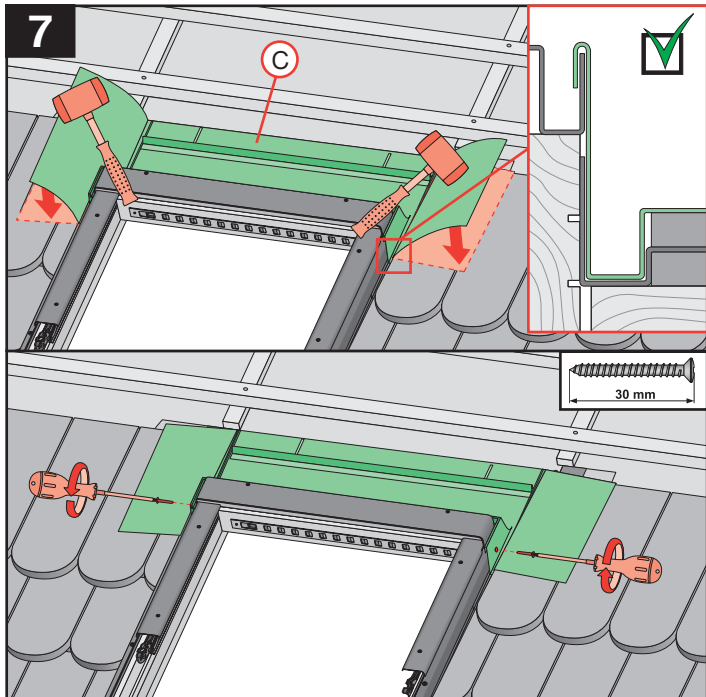
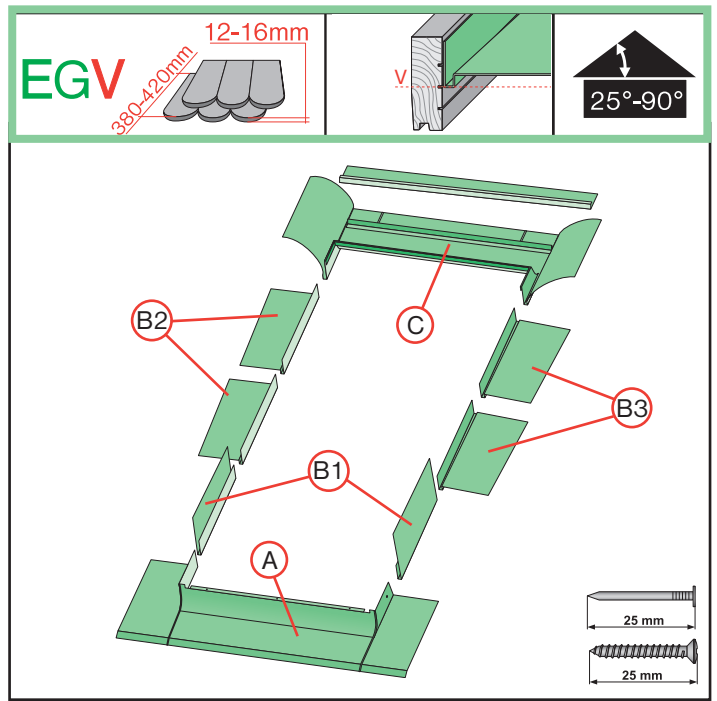
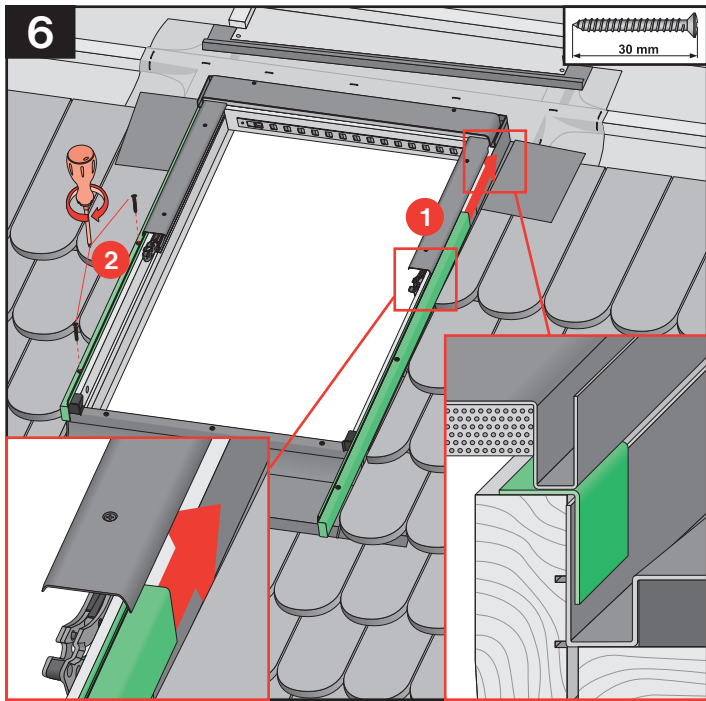

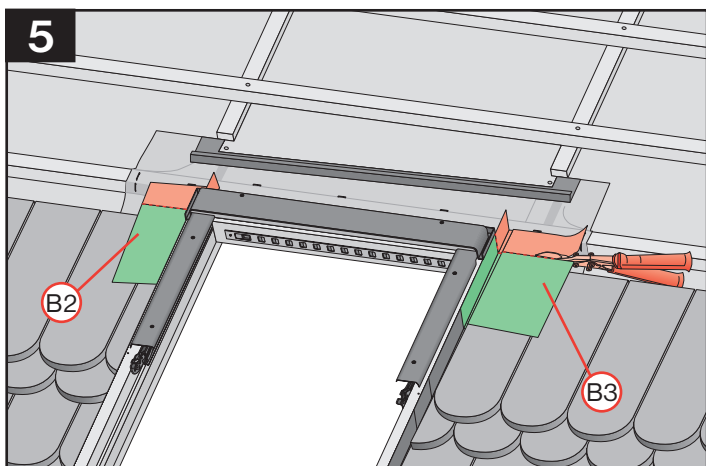
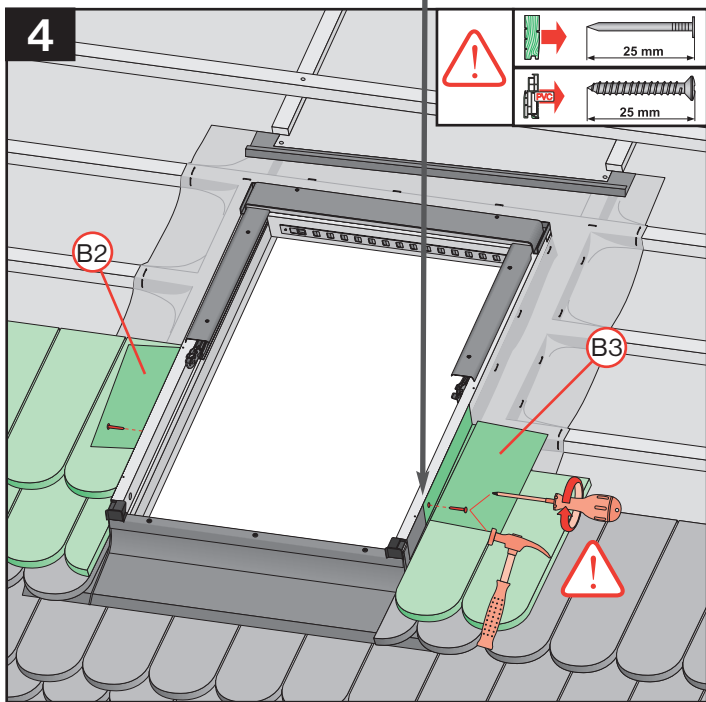
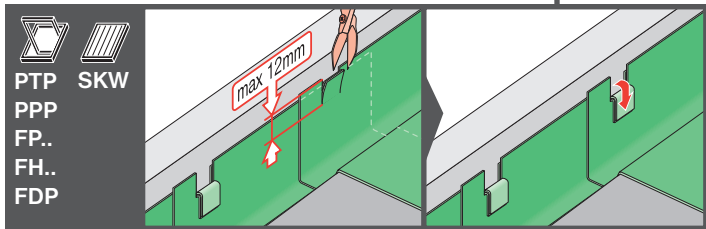
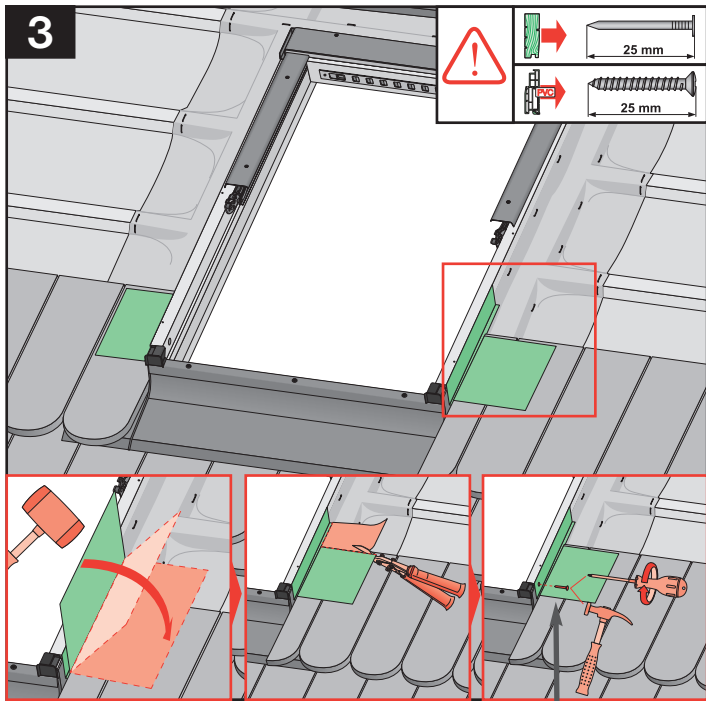

6

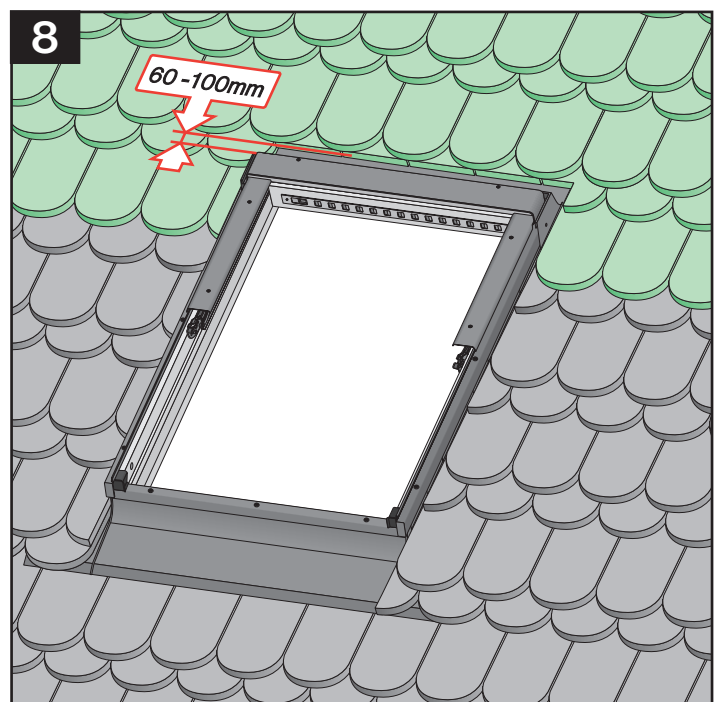
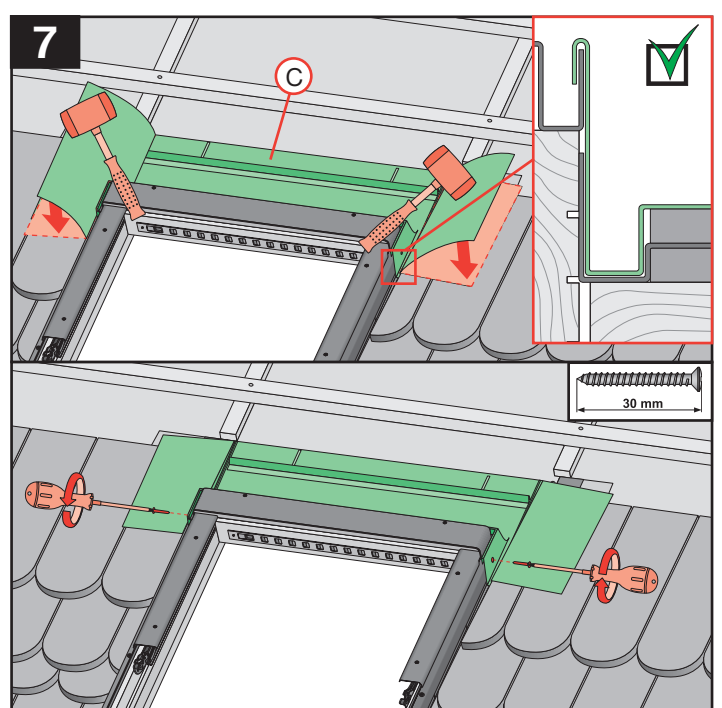
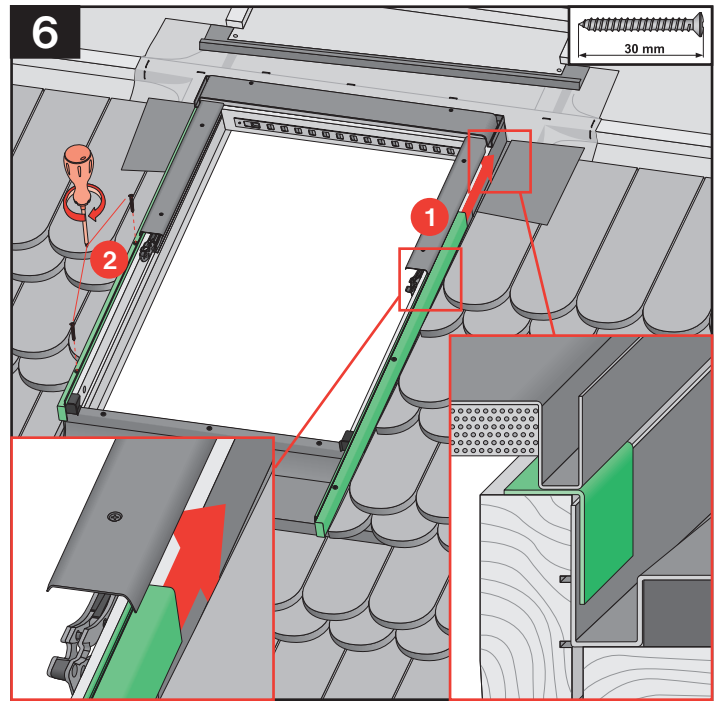

7